

Signet 525 Metalex Flow Sensor

English



P52590-1

Rev. K 11/06

English



SAFETY INSTRUCTIONS

1. Do not remove from pressurized lines.
2. Do not exceed maximum temperature/pressure specifications.
3. Pipe fitting must be installed by certified welder only.
4. Do not install/service without following installation instructions (see sensor manual).
5. Wear safety goggles and faceshield during installation/service.
6. Do not alter product construction.
7. Failure to follow safety instructions could result in severe personal injury!



Maximum Operating Temperature/Pressure:

Signet 525 Metalex Sensor with:

- Signet 526-1XXX Series Saddle Fitting: 21 bar @ 66°C (300 psi @ 150°F)
- Signet 526-2XXX Series Tee and Mini-Tap Fitting: 103 bar @ 149°C (1500 psi @ 300°F)

1. Location of Fitting

Recommended sensor upstream/downstream mounting requirements.

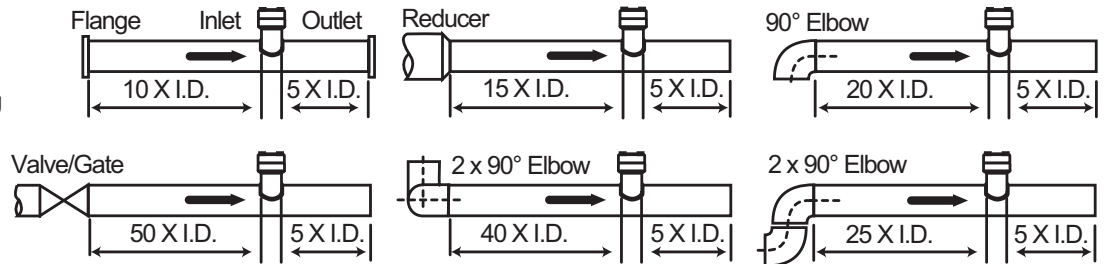

2. Sensor Mounting Position

- Horizontal pipe runs: Mount sensor in the upright (0°) position for best overall performance. Mount at a maximum of 45° when air bubbles are present. Do not mount on the bottom of pipe when sediments are present.
- Vertical pipe runs: Sensor must be mounted in lines with UPWARD flow only.

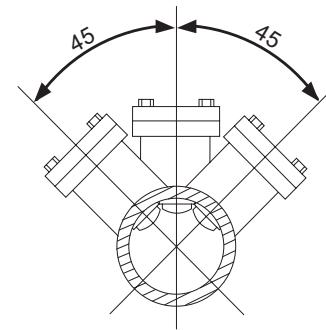

3. Sensor/Fitting Selection

The 525 is designed for installation into SCH 40 stainless steel pipes via Signet Metalex Tee, Mini-Tap or Saddle fittings, see options below:

Signet Metalex Tee Fittings (Sensor PN P525-1/-1S)

Pipe (in.)	Fitting	Code
0.50	P526-2005	198 840 501
0.75	P526-2007	198 840 502
1.00	P526-2010	198 840 503



525-1
Sensor

(525-1S for Stainless Steel)

Wetted fitting materials:
316 SS



Tee Fitting,
hardware included

Signet Metalex Mini-Tap Fittings (Sensor PN P525-2/-2S)

Pipe (in.)	Fitting	Code
1.25	P526-2012	159 000 494
1.50	P526-2015	198 840 506
2.00	P526-2020	159 000 495
2.50	P526-2025	159 000 496
3.00	P526-2030	159 000 497
4.00	P526-2040	159 000 498
5.00	P526-2050	159 000 499
6.00	P526-2060	159 000 500
8.00	P526-2080	159 000 501
10.0	P526-2100	159 000 502
12.0	P526-2120	159 000 503



525-2
Sensor

(525-2S for Stainless Steel Pin)

Wetted fitting materials:
316 SS & 347 SS



Mini-Tap Fitting,
hardware included

Signet Metalex Saddle Fittings (Sensor PN P525-3/-3S)

Pipe (in.)	Fitting	Code
2.00	P526-1020	159 000 484
2.50	P526-1025	159 000 485
3.00	P526-1030	159 000 486
4.00	P526-1040	159 000 487
5.00	P526-1050	159 000 488
6.00	P526-1060	159 000 489
8.00	P526-1080	159 000 490
10.0	P526-1100	159 000 491
12.0	P526-1120	159 000 492



525-3
Sensor

(525-3S for Stainless Steel Pin)

Wetted fitting materials:
Ductile Iron, 347 SS,
Carbon steel,
Buna-N/Neoprene

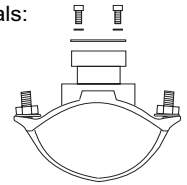

Saddle Fitting,
hardware included

4. Fitting Installation, Required Hardware

Signet Metalex Tee & Mini-Tap Fittings, P525-2XXX

- 0.5 to 1 inch pipes, P526-2 series fitting required
- 1.25 to 12 inch pipes: P526-2 series fitting and 27 mm (1-1/16 in.) diameter drill required
- Mini-Tap fittings are welded onto the pipe and are used with Signet 525-1 sensors.

Signet Metalex Saddle Fitting, P526-1XXX

- 27 mm (1-1/16 in.) diameter drill required

Saddle type fittings are strapped to the pipe and are used with Signet 525-3 sensors. Welds MUST be made by a certified welder who is licensed to weld stainless steel and other high-carbon grade steels.

4.1 Installation, Tee & Mini-Tap Fittings

1. Select an appropriate mounting location as outlined in sections 1 and 2.
2. Depressurize and drain pipe.
3. Use the following welding and installation procedures appropriate for your fitting/pipe size:

Signet Tee Fittings, 0.5 to 1 inch:

- Insert pipe into fitting socket
- Make sure the pipe is parallel to the bottom of the Mini-Tap fitting.

- Weld pipe into place

Signet Mini-Tap Fittings, 1.25 to 12 inch:

- Drill a 27 mm (1-1/16 in.) diameter hole completely through the ONE surface of the pipe. Thoroughly deburr inner and outer edges of hole.
- Tack weld the Mini-Tap fitting onto the pipe, making sure the hole in the pipe is lined up with the Mini-Tap fitting hole.
- Weld the Mini-Tap fitting onto the pipe.

4.2 Installation, Saddle Fittings

1. Select an appropriate mounting location as outlined in sections 1 and 2.
2. Drill a 27 mm (1-1/16 in.) diameter hole completely through the TOP surface of the pipe. Thoroughly deburr inner and outer edges of hole.
3. Place the Buna-N/Neoprene saddle O-ring over the pipe hole (small hole side towards pipe). Position the saddle fitting over the O-ring, making sure the O-ring centers on the underside fitting ridge. Center saddle fitting and O-ring over the pipe hole, then strap the fitting to the pipe with the two U-bolts. Snug all four nuts in a criss-cross pattern. Using a torque wrench (when possible) torque the U-bolts in a criss-cross pattern to 52 foot-pounds.

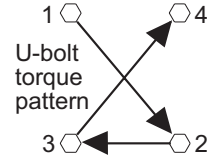

5. Sensor Installation

1. Set the gasket supplied with the fitting onto the fitting flange, making sure the holes align.
2. Remove the red rotor protection cap and insert the sensor into the fitting, making sure not to bump the rotor assembly. Make sure the arrow on the side of the sensor is pointing in the direction of flow.

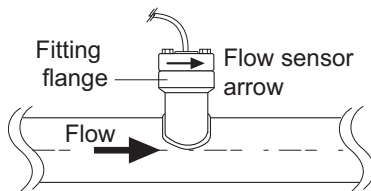

3. Slip two washers onto each bolt and insert the bolt/washer onto each of the four fitting flange holes.
4. Snug all four flange bolts in a criss-cross pattern. Using a torque wrench (when possible), torque the flange nuts in a criss-cross pattern to 52 foot-pounds.

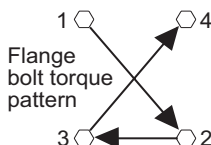

6. Sensor Wiring

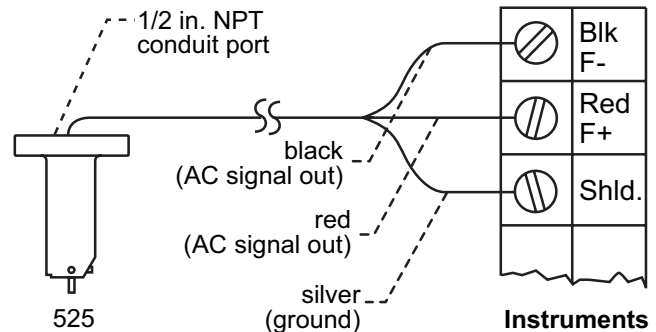

- Use 2-conductor shielded cable for cable splices to 60 m (200 ft)
- Maintain cable shield through splice.
- Shield the unjacketed silver (ground) wire using electrical tape to prevent potential noise interference and/or shorting hazards.
- Signet Inteltek-Pro, use 525 input card setting.

7. Sensor Removal Procedure

1. Depressurize and drain pipe.
2. Remove the four sensor flange bolts and lockwashers. Pull upward on the sensor flange with an alternating twisting motion.



WARNING!

Do not remove from pressurized lines. Wear safety goggles and faceshield during installation/service.

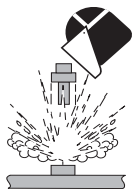

8. Maintenance

The 525 sensor requires little or no maintenance of any kind, with the exception of an occasional sensor/paddlewheel cleaning.

9. Rotor Replacement Procedure

1. With a small pair of needle-nose pliers, firmly grip the center of the rotor pin (axle) and with a twisting motion, bend the rotor pin into an "S" shape. This should pull the ends of the pin out of the retainers and free the rotor assembly.

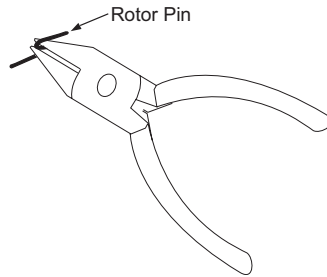

2. Remove retainer from each side by gently tapping it inwards using a punch. Install a new retainer with its rotor pin clearance hole inward. Only install one retainer at this time.

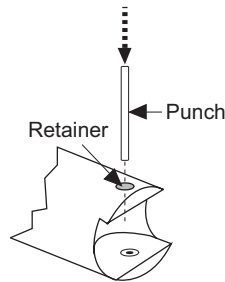

3. Insert the new rotor assembly and bearings into the rotor housing of the sensor and place the new rotor pin (axle) through the open end of the rotor housing, through the rotor and bearings, and into the previously installed retainer.

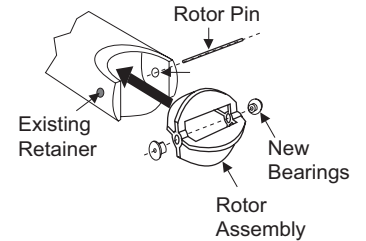

4. Tap the second retainer (rotor pin clearance hole inwards) into the hole while lining up the rotor pin with the center of the retainer hole. This completes the rotor replacement procedure.

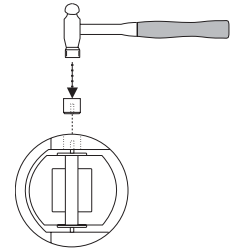

10. K-Factors

The K-Factor is the number of pulses the sensor will generate for each engineering unit of fluid which passes. They are listed in U.S. gallons and in liters. For example, in a 1 inch SCH 40S stainless steel pipe, the sensor generates 266.17 pulses per gallon of fluid passing the rotor. K-Factors are listed for SCH 40S stainless steel pipes up to 12 inch.

SCH 40S STAINLESS STEEL PIPE PER ANSI B36.19				
PIPE SIZE	K-FACTOR PULSES/ U.S. GAL	K-FACTOR PULSES/ U.S. LITER	A-FACTOR GPM/Hz	A-FACTOR LPM/Hz
1/2 IN.	873.03	230.66	0.0687	0.2601
3/4 IN.	515.41	136.17	0.1164	0.4406
1 IN.	266.17	70.322	0.2254	0.8532
1 1/4 IN.	148.84	39.324	0.4031	1.5258
1 1/2 IN.	107.98	28.528	0.5557	2.1032
2 IN.	64.808	17.122	0.9258	3.5042
2 1/2 IN.	44.685	11.806	1.3427	5.0822
3 IN.	28.579	7.5506	2.0994	7.9464
4 IN.	16.302	4.3070	3.6805	13.931
5 IN.	10.237	2.7046	5.8611	22.184
6 IN.	7.0057	1.8509	8.5645	32.416
8 IN.	3.9641	1.0473	15.136	57.289
10 IN.	2.4690	0.6523	24.301	91.981
12 IN.	1.6894	0.4463	35.516	134.43

Conversion Formulas

1 U.S. gallon = 0.003785 cubic meters
 0.000003069 Acre feet
 8.3454 pounds of water

11. Specifications

General Data

Flow velocity range: 0.5 to 6 m/s (1.6 to 20 ft/s)
 Frequency output: 29 to 46 hz per m/s (9 to 14 hz per ft/s)
 (depending on pipe size)
 Linearity: $\pm 1\%$ of full range
 Repeatability: $\pm 0.5\%$ of full range
 Pipe size range: 13 to 305 mm (0.5 to 12 in.)
 Cable length: 7.6 m (25 ft), can splice to 60 m (200 ft.)
 with no significant degradation of signal strength
 Cable type: 150°C 22 AWG, 2-conductor w/shield

Wetted Materials

Sensor body: ACI type CF-8M (316 cast stainless steel)
 per ASTM A351
 Rotor material: CB7Cu-1 Alloy
 Rotor pin: Tungsten Carbide GRP 1 (standard);
 316 stainless steel (optional)
 Retainers (2): 316 stainless steel
 Rotor bearings (2): Fluoroloy B®

Electrical Data

Voltage output: Approximate sine wave, 0.005 to 0.008
 Vp-p per Hertz
 Coil resistance: 11.6 kW @ 25°C
 Coil inductance: 3.5 Henrys @ 25°C

Quality Standards

- CE, FM
- Manufactured under ISO 9001

Ambient Conditions

Maximum Pressure/Temperature Limitations:

Signet 525 Metalex Sensor with:

- Signet 526-1 Series Saddle Fitting:
 21 bar @ 66°C (300 psi @ 150°F)

Signet 525 Metalex Sensor with:

- Signet 526-2 Series Tee or Mini-Tap Fitting:
 103 bar @ 149°C (1500 psi @ 300°F)

Mfr. Part No.	Code
P525-1	198 801 494
P525-2	198 801 495
P525-3	198 801 496
P525-1S	159 000 963
P525-2S	159 000 964
P525-3S	159 000 965

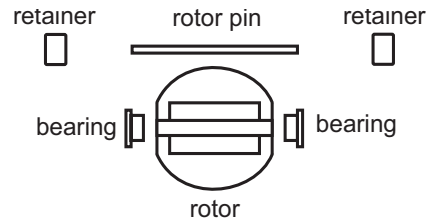

P52509/P52509-2 Rotor kit

Accessories and Replacements Parts

Mfr. Part No.	Code	Description
P52509	198 801 501	Rotor kit w/Tungsten Carbide pin Fluoroloy-B bearings, 316 ss retainers
P52509-2	159 000 480	Rotor kit w/Tungsten Carbide pin Fluoroloy-B bearings, 316 ss retainers
P52504-1	198 801 500	Rotor Pin, Stainless steel (optional)
P52504-2	198 820 023	Rotor Pin, Tungsten Carbide (standard)
P52618	159 000 493	Gasket
P52503	198 820 013	Bearing, Fluoroloy B®
P52527	159 000 481	Retainers, Stainless steel
P52628	159 000 504	Fitting cap kit (cap and gasket)
P51589	159 000 476	Conduit Adapter Kit
5523-3222	159 000 393	Cable (per foot) 2 cond. w/shield, 22 AWG



George Fischer Signet, Inc., 3401 Aerojet Avenue, El Monte, CA 91731-2882 U.S.A. • Tel. (626) 571-2770 • Fax (626) 573-2057
 For Worldwide Sales and Service, visit our website: www.gfsignet.com • Or call (in the U.S.): (800) 854-4090

